

## Introduction

Your Veeder-Root brand C628 Dual Preset Counter is one model in a family of 1/8 DIN units which offers breakthrough display technology as well as easy-to-program single-line parameters. Designed to provide instant visual feedback regarding an application's key input value, the C628 not only has a 0.71" high LED display (27% larger than other 1/8 DIN units), but also the ability to change display color based on process status (programmable parameter in Operation Mode). Easy programming is made possible via a help function and a secondary legend display.

This manual will guide you through the installation and wiring of your C628 unit with information on proper panel mounting and rear terminal layout and wiring instructions. In addition, the instrument's operation and programming modes are thoroughly explained. The Operation Mode provides day to day operation and allows editing of preset values. The Program Mode enables the configuration of various parameters prior to initial operation. These parameters include those for basic configuration as well as other settable features which will enhance the functionality and usability of the device.

This manual also provides information on the C628 Dual Preset Counter's two presets, transistor and relay outputs, product specifications, and ordering and warranty procedures.



### Features

- AWESOME 0.71" high digit LED display
- Programmable color change display based on an event
- Programmable help function and secondary legend display
- Preset 1 programmable as absolute value or Prewarn which tracks Preset 2
- Choice of NPN or PNP primary input
- Filter speed settable for 20, 200, or 10,000 Hz
- Standard outputs: two NPN transistors & one relay (optional 2nd relay)
- Front panel reset enable and preset lockout
- Optional RS-485 plug in card
- CE approved

### Index

Installation	
Panel Mounting	page 2
Wiring	page 3
Operation	
Front Panel	page 4
Operation Mode	page 5
Programming	
Program Mode	page 6-10
Appendix A	
Specifications	page 11
General	
Ordering Information	page 12
Warranty	page 12

*Technical Manual  
702138-0007*

**Veeder-Root** brand  
**Series C628**  
**Dual Preset**  
**Counter**  
**(C628-8XXX)**

# INSTALLATION

## PANEL MOUNTING

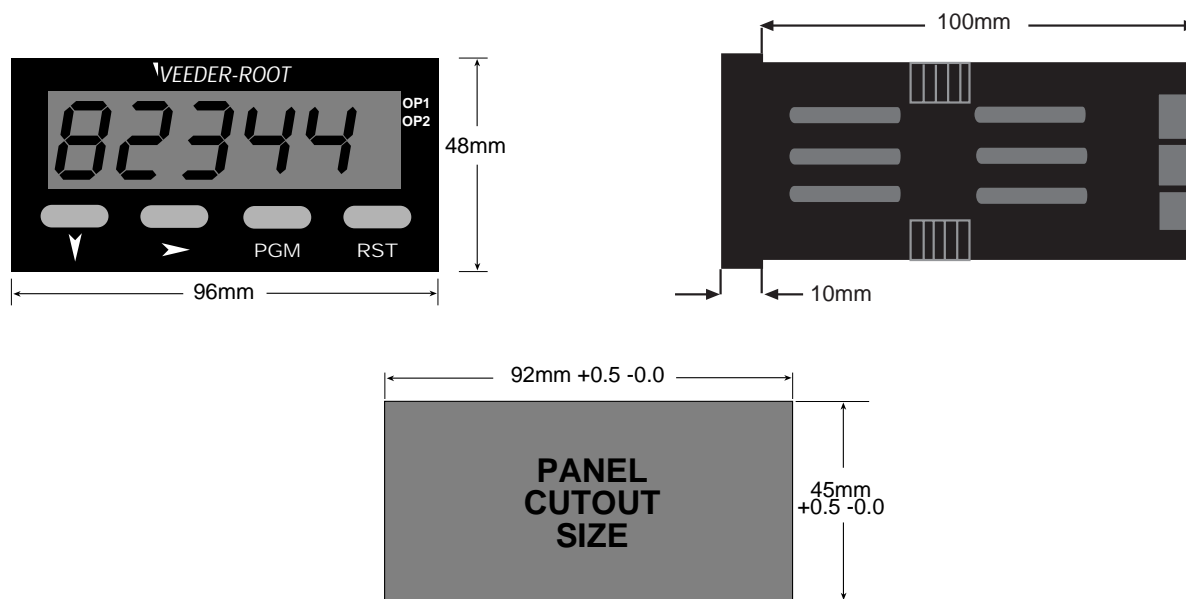

The instrument can be mounted in a panel with a thickness of up to 6mm. The cutout(s) should be made based on the recommended panel opening illustrated in the drawing above.

### Mounting Grooves

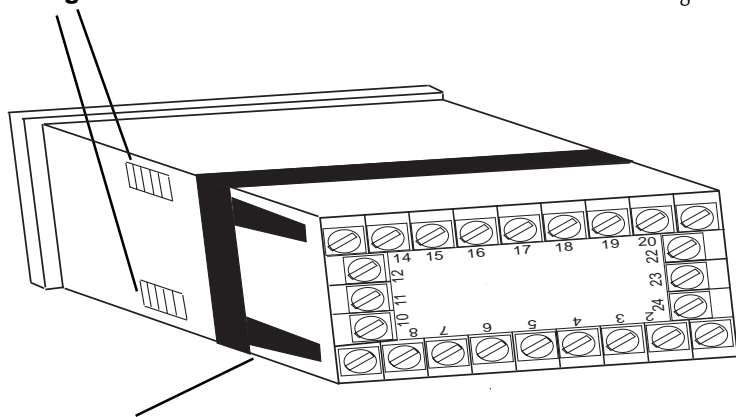

Insert the unit in the panel through the cutout. Ensure that the panel gasket is not distorted and the instrument is positioned squarely against the panel. Slide the mounting clamp into place on the instrument, as shown to the left, and push it forward until it is firmly in contact with the rear face of the mounting panel and the tabs on the bracket arm are seated in the mounting grooves on the side of the unit.

The electronic components of the instrument can be removed from the housing after installation without disconnecting the wiring. To remove the components, grip the side edges of the panel and pull the instrument forward. Take note of orientation of the unit for subsequent replacement in the housing.

### Bracket Arm

# INSTALLATION

## WIRING

### REAR TERMINAL CONNECTIONS

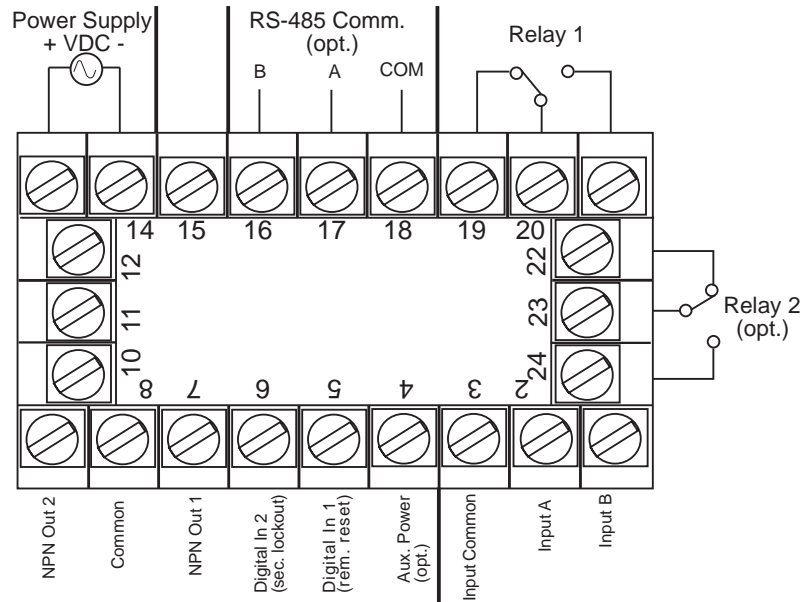

#### Count Inputs

Terminal #2 is the connection for Input A, which is programmable to be the primary input or channel A of an encoder input. Terminal #1 is the connection for Input B, which is programmable to be an incrementing input, a decrementing input, or channel B of an encoder input. The common connection for both Input A and Input B is Terminal #3.

#### Control/Digital Inputs

A contact closure or NPN signal can be used to activate preconfigured functionality. Terminal #5 is used for a remote reset function, while Terminal #6 is a security function, that when active, will prohibit entry into Program Mode. Terminal #8 serves as the common for both of these inputs.

#### Auxiliary Power Output

A 9 - 15 VDC for powering external sensors and encoders up to 125 mA can be accessed by connecting the positive supply side of the sensor to Terminal #4 and the negative side to Terminal #8.

#### Input Power

For an AC powered unit, Terminal #13 serves as the line or Hot side connection for AC powered units and as the positive side for DC powered

units. The neutral side for AC powered units and the negative side for DC powered units are connected to Terminal #14.

#### Transistor Outputs

Your unit comes standard with 2 NPN outputs which are activated by each of the presets. Transistor Output 1, which is tied to Preset 1 operation, is on Terminal #7. Transistor Output 2, which is tied to Preset 2 operation, is on Terminal #9. Terminal #8 serves as the common connection for the transistor output.

#### Relay Outputs

Your unit comes standard with a relay output which is tied to Preset 1 operation. Terminal #19 is NC, Terminal #20 is common, and Terminal #21 is NO. A second relay output tied to the operation of Preset 2 can be added as an option at the time of order or later installed in the field. Terminal #22 is NC, Terminal #23 is common, and Terminal #24 is NO.

#### Serial Communication

An RS-485 communication board, utilizing ASCII protocol, can be installed as an option. Terminals #16 & #17 serve as the B and A connections respectively, while Terminal #18 is connected as the common.

**Terminals 10, 11, 12, & 15 are not used.**

# OPERATION

## FRONT PANEL

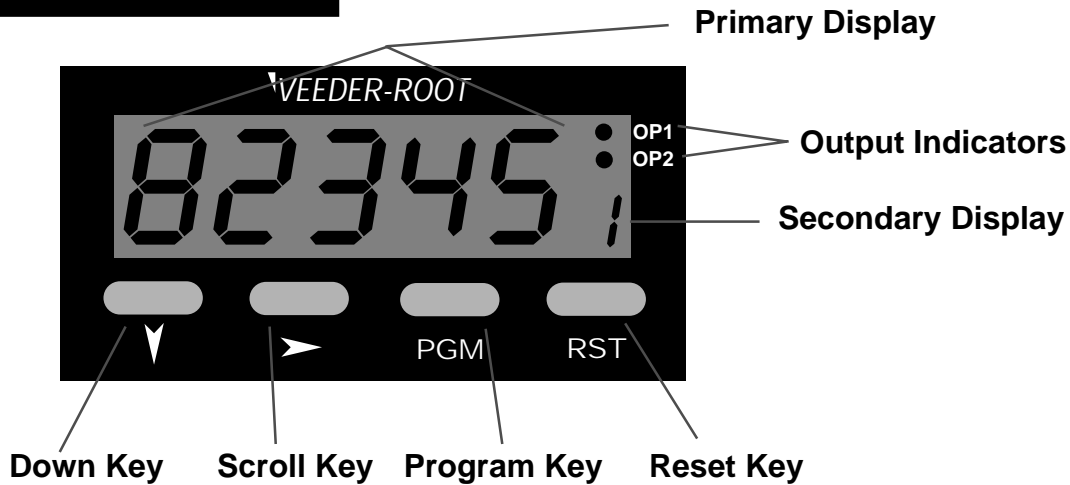

### Key Functions

Key	Function
Down	<i>In Operation Mode:</i> Used in edit operation to decrement the digit highlighted by the Scroll key. <i>In Program Mode:</i> Used in Edit Operation to decrement the digit highlighted by the Scroll key, if the setting is a numerical value, or present the next in the series of choices for that parameter.
Scroll	<i>In All modes:</i> Moves the unit into Edit Operation, which is indicated by the left most digit flashing. Successive presses of the key are used to move to the digit to be edited. Wrap around will occur from least significant digit to most significant digit.
Program	<i>In Operation Mode:</i> Used to move between the count value display & the presets and to enter an edited preset value. Holding the key down for 3 seconds will cause the unit to enter Program Mode. <i>In Program Mode:</i> Used to move from one parameter to the next and enter the edited parameter values. Holding the key down for 3 seconds will cause the unit to return to Operation Mode.
Reset	<i>In Operation Mode:</i> Resets the count value to zero (or to the preset in count down operation). This button can be disabled via the "Front Panel Reset Enable" parameter in Program Mode. <i>In Program Mode:</i> No function.
Down & Scroll together	<i>In All modes:</i> Will abort an Edit Operation and return the preset/parameter to its previous value.

### Display Functions

Display	Function
Primary	<i>In Operation Mode:</i> Default display is the count value. Can be scrolled using the program key to display the Preset 1 and 2 values. If the "Help" function is enabled, this display will first show the parameter description for 3 seconds (see page 5 for example). <i>In Program Mode:</i> Displays the value or selection for the current parameter. If the "Help" function is enabled, this display will first show the parameter description for 3 seconds (see page 6 for example).
Secondary	<i>In Operation Mode:</i> Indicates numerically whether Preset 1 or 2 is being viewed on the primary display. This display is blank when the Count Value is being shown. <i>In Program Mode:</i> Provides a 1 digit alpha or numeric character to indicate which parameter value is being shown on the primary display.
Output Indicators	<i>In Operation Mode:</i> OP1 illuminates when Output 1 is active. OP2 illuminates when Output 2 is active. <i>In Program Mode:</i> No function.

# OPERATION

## OPERATION MODE

### CHANGING A PRESET VALUE



Default display is the present count value.



Pressing the Program Key will cause the display description to appear on the main display.\* If there is no key activity for 3 seconds, the primary display will switch back to the count value.



Continued pressing of the Program Key will scroll through the Preset. (See Parameter Sequence below.) The full parameter description will appear on the main display.\*



To change the Preset value, press the Scroll Key. If there was no key activity for 3 seconds, the Preset value will appear (one digit description shown on secondary display); however, press the Scroll Key in order to edit. The unit will now be in Edit Operation as signified by the most significant digit flashing.\*\*

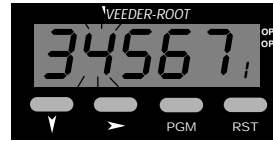

Use the Scroll Key to move from left to right and highlight the digit that needs to be changed. Wrap around will occur from the least significant to the most significant digit.

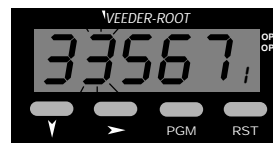

Use the Down Key to decrement the digit until the desired value appears. The display will wrap around from 0 to 9.

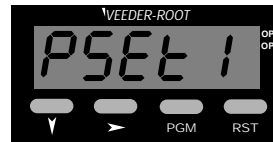

After the desired digits have been changed, press the Program Key to enter the new value. The new value will appear on the main display without any flashing digits. Press the Program Key again and the parameter description will appear on the main display.

\* Parameter descriptions will not appear on the primary display if the "Help" function has been disabled.

\*\* Edit Operation cannot be accessed if the Preset Lock has been enabled in Program Mode.

### PARAMETER SEQUENCE



#### Count

*Function:* Displays present count value  
*Range:* 0 to 99999

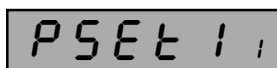

#### Preset 1

(mutually exclusive with Prewarn)

*Function:* Defines the value at which Output 1 will be activated

*Adjustment Range:* 0 to 99999

*Default Value:* 10

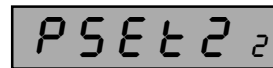

#### Preset 2

*Function:* Defines the value at which Output 2 will be activated

*Adjustment Range:* 0 to 99999

*Default Value:* 10

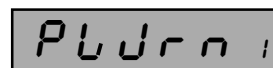

#### Prewarn

(mutually exclusive with Preset 1)

*Function:* Sets Preset 2 as a value relative to Preset 1. The input value of Preset 2 equals the count value that Output 2 will activate prior to Output 1.

*Adjustment Range:* 0 to 99999

*Default Value:* 10

# PROGRAMMING

## PROGRAM MODE

### ENTERING PROGRAM MODE AND BASIC OPERATION

The Program Mode can be accessed from the Operation Mode by holding the Program Key for 3 seconds.

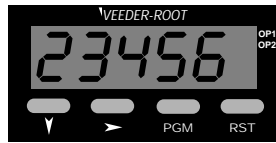

PGM for 3 seconds

The name of the first parameter will appear on the primary display.\*

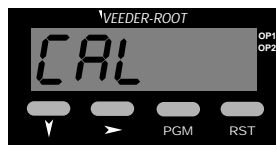

PGM

Successive presses of the Program Key will scroll the display through the remaining parameters in the Program Mode. To exit Program Mode, hold the Program Key for 3 seconds.



no key activity for 3 secs. or

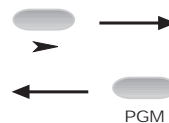

### Edit Operation

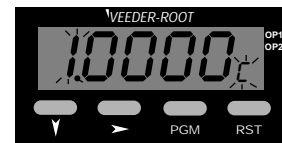

Pressing the Scroll Key or no key activity for 3 seconds will display the value for that parameter. The secondary display will indicate the one digit identifier for the parameter. The digit in the secondary display will flash to indicate the unit is in Program Mode. If the Scroll Key was pressed (instead of waiting 3 seconds), the unit is in Edit Operation, as indicated by the MSD flashing. If there had been no key activity for 3 seconds, press the scroll key to enter Edit Operation (MSD flashing). Use the scroll and edit buttons to change the value as in Operation Mode, described on page 5. Press the Program Key to enter any changes.

\* Parameter names will not appear on the main display if the "Help" function has been disabled in Program Mode.

### PARAMETER SEQUENCE

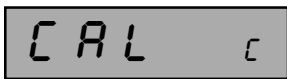

PGM

#### Calibration Factor

*Function:* Used to scale the input into engineering units by multiplying this value by the number of pulses received

*Adjustment Range:* 0.0001 to 9.9999

*Default Value:* 1.0000

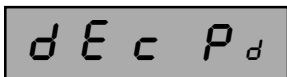

PGM

#### Decimal Position

*Function:* Set the decimal point position for the count and preset displays

*Adjustment Range:* 0 to 0.0000

*Default Value:* 0

## PROGRAM MODE Continued

count<sub>c</sub>

### Count Mode

*Function:* Defines how the input pulses will be applied to the count value

*Adjustment Range:*

A + B

A+B: Inputs on both the A & B channels increment the total

A - B

A-B: Inputs on the A channel increment the total, while inputs on the B channel decrement

dir

Directional: When input B is inactive, input A increments. When input B is active, input A decrements

QuAd

Quadrature: The unit accepts a phased input from an encoder. The total increments when the A channel leads the B channel

*Default Value:* A+B



UP dn

### Count Direction

*Function:* Determines if the count value will increment from zero and change the state of the output at the preset (Up) or decrement from the preset and change the state of the output at zero (Down)

*Adjustment Range:*

UP

Up: The unit will count up from zero and activate the output(s) when the preset(s) is reached

dn

Down: Upon reset, the unit will begin at Preset 1 and count down. The preset output will be activated when the count value reaches zero

UP\_Ar

Up with Auto Reset: The unit will count up from zero and activate the output(s) when the preset(s) is reached, then automatically reset the count value to zero and continue operating

dn\_Ar

Down with Auto Reset: The unit will begin at Preset 2 and incremental pulses will cause the unit to count down. The preset output will be activated when the count value reaches zero. The unit will automatically reset its count value and continue operating

*Default Value:* Up



PrnOd P

### Preset Mode

*Function:* Determines whether the setting tied to Output 1 will be utilized as an absolute value or a tracking value

*Adjustment Range:*

PSEt 1

Preset 1: The setting tied to Output 1 will be utilized as an absolute value

PLDrn

Prewarn: The setting tied to Output 1 will be utilized as a tracking value

*Default Value:* Preset 1



## PROGRAM MODE Continued

Input,

### Input Type

*Function:* Programs the unit to match the electrical characteristics of the input signal

*Adjustment Range:*

Sin

Src

Sinking: The unit will accept a NPN or dry contact input which sinks voltage to common

Source: The unit will accept a PNP input which sources voltage

*Default Value:* Sinking



SPEED F

### Filter Speed

*Function:* Enables the debounce filter of the counter to properly match the application

*Adjustment Range:*

20

200

10000

20: The unit will accept up to 20 pulses per second. Generally used with contact inputs to eliminate false counts caused by contact bounce

200: The unit will accept up to 200 pulses per second. Generally used for higher speed contact inputs or to filter noise on electronic signals in low speed applications

10,000: The unit will accept up to 10,000 pulses per second. Generally used with high speed electronic inputs and encoders

*Default Value:* 10000



Out 1

### Output 1 Time

*Function:* Sets the amount of time Output 1 will be active once Preset 1 is reached

*Adjustment Range:* 00.00 (Latched) to 99.99

*Default Value:* 1.00



Out 2

### Output 2 Time

*Function:* Sets the amount of time Output 2 will be active once Preset 2 is reached

*Adjustment Range:* 00.00 (Latched) to 99.99

*Default Value:* 1.00





## PROGRAM MODE Continued



### Front Panel Reset Enable

*Function:* Determines whether the Front Panel Reset key can be used to reset the count value

*Adjustment Range:*

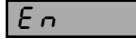

**Enable:** The count value can be reset while being viewed in Operation Mode by pressing the Front Panel Reset Key

**Disabled:** The Front Panel Reset Key is disabled and the count value can only be reset through the Remote Reset Input

*Default Value:* Enable



### Serial Communication Enabled

*Function:* Activates the RS-485 communication option board

*Adjustment Range:*



**None:** No communication board installed

**Fitted:** A communication board is installed in the unit

*Default Value:* If ordered from the factory with the RS-485 board, the default will be "fitted". If the board is installed in the field, this parameter will need to be changed from its default of "none"



### Communication Address *(Appears only if communication board is installed and activated)*

*Function:* Defines the unique communication address of the counter

*Adjustment Range:* 1 to 99

*Default Value:* 1



### Baud Rate *(Appears only if communication board is installed and activated)*

*Function:* Selects the serial communication speed

*Adjustment Range:*

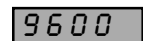
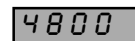
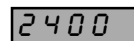
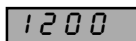

1200 BPS

2400 BPS

4800 BPS

9600 BPS

*Default Value:* 4800



## PROGRAM MODE Continued

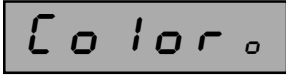

### Display Color Change

*Function:* Defines the color of the display for prior to and after the preset value is reached

*Adjustment Range:*

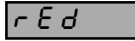

Red: The display will always be red

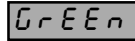

Green: The display will always be green



Green to Red: The display will be green prior to the Preset 2 value being reached. It will turn red after Preset 2 has been reached

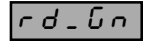

Red to Green: The display will be red prior to the Preset 2 value being reached. It will turn green after Preset 2 has been reached

*Default Value:* Green to Red

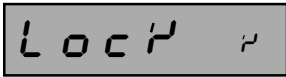

### Preset Lock

*Function:* Determines whether the Preset Values can be changed via the front panel

*Adjustment Range:*



Enable: Preset values are read only



Disabled: Preset values can be viewed and changed

*Default Value:* Disable



### Help Prompt

*Function:* Determines whether the multi-character parameter name will appear on the main display for 3 seconds prior to the parameter value appearing

*Adjustment Range:*

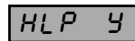

Help - Yes: Multi-character parameter descriptions will appear on the primary display. The value associated with that parameter will appear by pressing the scroll key or waiting for 3 seconds

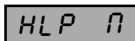

Help - No: Only the parameter values will appear on the primary display. The parameter can be identified by a single digit in the secondary display

*Default Value:* Help - Yes

## SPECIFICATIONS

### Count Inputs

Type: Sinking/Sourcing or Contact Closure  
 Frequency: 10 kHz max.  
 Logic: Low  $\leq$  2.0 VDC, High  $\geq$  3.0, 30V max.  
 Impedance: 10 K $\Omega$  to common - Sourcing  
 4.7 K $\Omega$  to +Voltage - Sinking  
 Count Modes: A+B, A-B, Directional, Quadrature

### Control Inputs

Type: Sinking, Edge Sensitive  
 Logic: Low  $\leq$  2.0 VDC, High  $\geq$  3.0  
 Impedance: 4.7 K $\Omega$  to +Voltage  
 Response Time: 25 ms  
 Function: Input 1: Remote Reset  
 Input 2: Security Lockout

### Outputs

Solid State: NPN open collector, 30 VDC max, 100 mA max.  
 Relay: SPDT, 5A resistive @ 110VAC  
 Latency: 75  $\mu$  seconds, plus 8 ms for relay pull-in

### Approvals

General: CE  
 EMC Susceptibility: Complies with EN50082-1: 1992,  
 EN50082-2: 1995  
 EMC Emissions: Complies with EN50081-1: 1992,  
 EN50081-2: 1994  
 Safety: Complies with EN61010-1: 1993

### Communication

Type: Serial asynchronous, UART to UART  
 Data Format: Open ASCII: One start bit, even parity seven  
 data bits, one stop bit  
 Physical Layer: RS-485  
 Maximum Zones: 99  
 Baud Rate: Selectable from 9600, 4800, 2400, or 1200

### Electrical

Supply Voltage: 90-264 VAC, 50/60 Hz, or 20-50 VAC/VDC  
 Power Consumption: 4 Watts  
 Access. Power Supply: 9-15 (unregulated VDC), 125 mA max.

### Display

Type: Red/Green, 7 segment LED, 5 digits primary  
 display, single digit secondary display  
 Height: 0.71" (18mm) primary display,  
 0.3" (7mm) secondary display  
 Annunciators: Output 1 & 2 status

### Physical

Dimensions: 48mm x 96mm, 110mm deep  
 Mounting: Panel mount (mounting bracket supplied),  
 45mm x 92mm cutout  
 Terminals: Screw type - combination head  
 Front Panel Rating: NEMA 4X/IEC IP65  
 Case Material: GE Lexan 940  
 Weight: 0.56 lbs.

### Environmental

Operating Temp.: 0° to 55° Celsius, 32° to 131° Fahrenheit  
 Storage Temp.: -20° to 80° Celsius, -4° to 176° Fahrenheit  
 Relative Humidity: 20% to 95% non-condensing

# GENERAL

## ORDERING INFORMATION

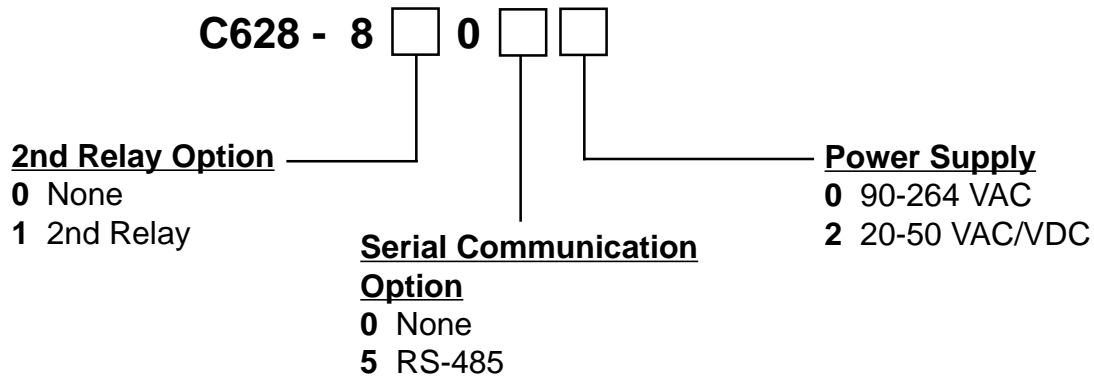

Additional outputs and options can be field installed through plug-in boards which can be ordered separately.

Description	Part #
Relay Board	T50-001
RS-485 Comm. Board	T50-005

## WARRANTY

Standard products manufactured by the Company are warranted to be free from defects in workmanship and material for a period of one year from the date of shipment, and products which are defective in workmanship or material will be repaired or replaced, at the option of the Company, at no charge to the Buyer. Final determination as to whether a product is actually defective rests with the Company. The obligation of the Company hereunder shall be limited solely to repair and replacement of products that fall within the foregoing limitations, and shall be conditioned upon receipt by the Company of written notice of any alleged defects or deficiency promptly after discovery within the warranty period, and in the case of components or units purchased by the Company, the obligation of the Company shall not exceed the settlement that the Company is able to obtain from the supplier thereof. No products shall be returned to the Company without its prior consent. Products which

the Company consents to have returned shall be shipped F.O.B. the Company's factory. The Company cannot assume responsibility or accept invoices for unauthorized repairs to its components, even though defective. The life of the products of the Company depends, to a large extent, upon the type of usage thereof, and THE COMPANY MAKES NO WARRANTY AS TO FITNESS OF ITS PRODUCTS FOR SPECIFIC APPLICATIONS BY THE BUYER NOR AS TO PERIOD OF SERVICE UNLESS THE COMPANY SPECIFICALLY AGREES OTHERWISE IN WRITING AFTER THE PROPOSED USAGE HAS BEEN MADE KNOWN TO IT.

THE FOREGOING WARRANTY IS EXCLUSIVE AND IN LIEU OF ALL OTHER WARRANTIES EXPRESSED OR IMPLIED, INCLUDING, BUT NOT LIMITED TO ANY WARRANTY OF MERCHANTABILITY OR OF FITNESS FOR A PARTICULAR PURPOSE.

Printed in U.S.A.  
702138-0007  
March 1998  
Revision none

 **Danaher Controls**

1675 Delany Road  
Gurnee, IL 60031-1282  
Phone: 847.662.2666  
Fax: 847.662.6633